

905nm 300W Pulsed Laser Diodes

Model: OPT905TO300-M

Features

- Hermetic Package
- Peak Power up to 300W

Applications

- Range finding
- Surveying equipment
- Weapons simulation
- Laser radar
- Ceilometer
- Optical trigger
- Medical

Optical Characteristics at $t_{RT}=25\text{ }^{\circ}\text{C}$

	Min.	Typ.	Max.	Units
Wavelength of peak radiant intensity λ m	895	905	915	nm
Spectral bandwidth $\Delta\lambda$ at 50% intensity points		7		nm
Wavelength temperature coefficient		0.28		nm/ $^{\circ}\text{C}$
Beam spread (50% peak intensity)				
Parallel to junction plane //		10		Degrees
Perpendicular to junction plane \perp		22		Degrees

Optical Characteristics at $t_{RT}=25\text{ }^{\circ}\text{C}$, $t_w=100\text{ ns}$, $D=0.1\%$, $I_F=50\text{ A}$

Parameter		Units
Number of elements	2×4	
Peak output power (typ.)	300	W
Emitting area	220×120	μm
Threshold, I_{th} typ.	900	mA
Forward voltage at I_F	17	V

Absolute Maximum Ratings

Maximum ratings	Limiting values
Max. current	50A
Peak reverse voltage	17V
Pulse duration	100ns
Duty factor	0.1%
Temperature	
- Storage	-40°C to +125°C
- Operating	-40°C to +105°C
Lead soldering	
- 1 0 seconds max at	260°C

Package Drawings

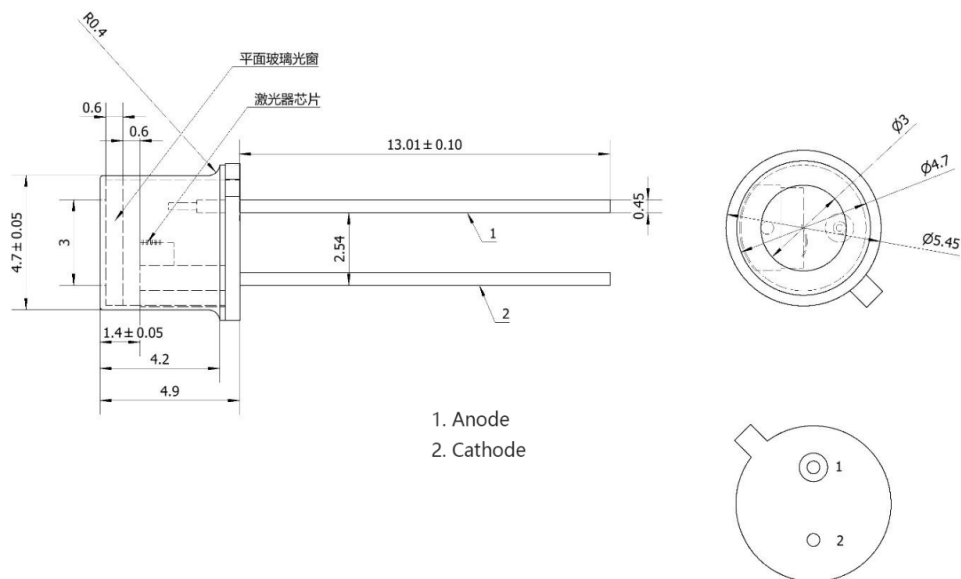

Curve of spectrum

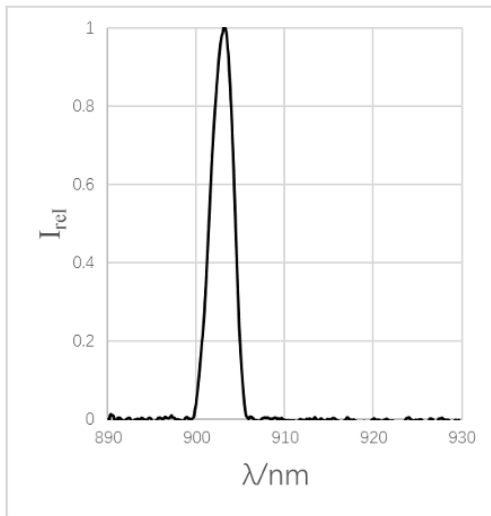

Power vs. Current (Single chip)

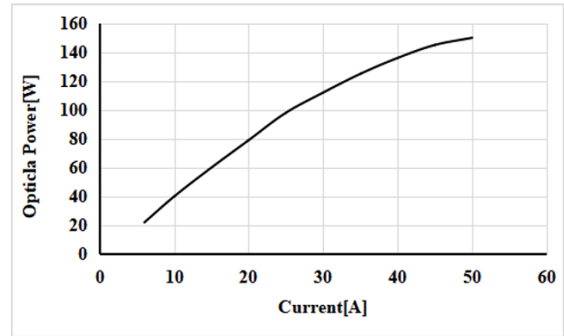

Beam spread

